

SURFACE ROUGHNESS				
Ra	25	6.3	1.6	0.2
Rmax	100S	25S	6.3S	0.8S

REV.	DATE	NOTE	DRW.

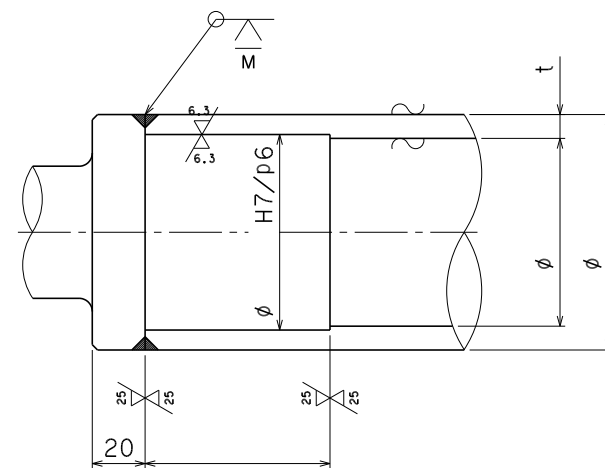
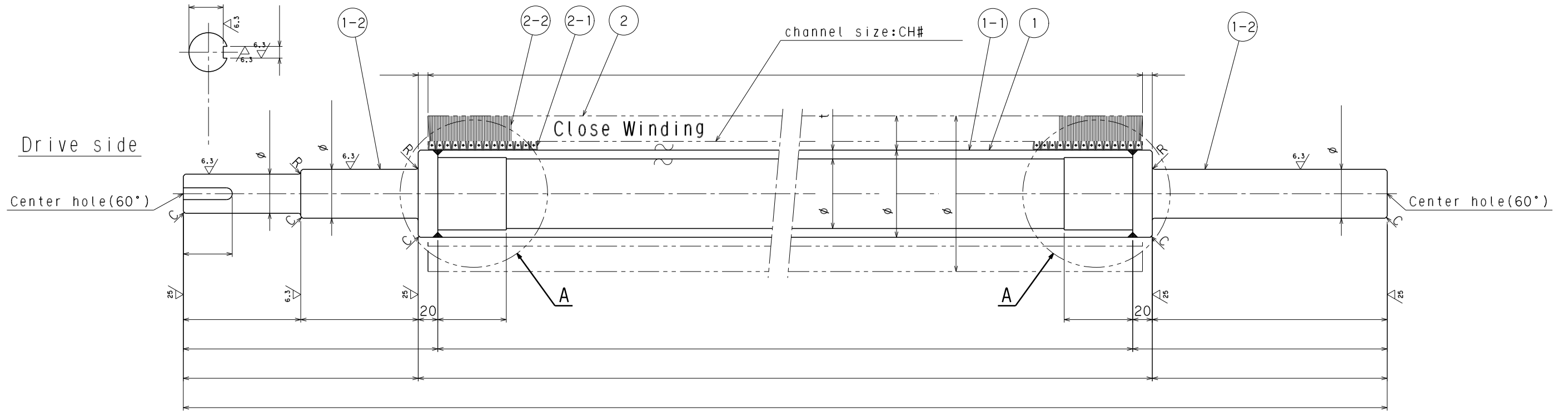

2-2	BRISTLE	1set			
2-1	CHANNEL	1set			CH#
2	BRUSH	1set			
1-2	JOURNAL	2			
1-1	PIPE	1			seamless
1	SHAFT	1			

PARTS No.	PARTS NAME	Q'TY (PER SET)	MATERIAL	WEIGHT (kg)	REMARKS
CUSTOMER:					
APPROVED	TITLE SK Type Channel Roll Brushes (Close Winding/Pipe Shaft/Drive side 2-stepped)				
CHECKED	SCALE		DRAWING No.		
DRAWN	NTS				
DATE	SHOWA INDUSTRIES CO.,LTD.				

