

SURFACE ROUGHNESS						
Ra		25	6.3	3.2	1.6	0.2
Rmax		100S	25S	12.5S	6.3S	0.8S

REV.	DATE	NOTE	DRW.

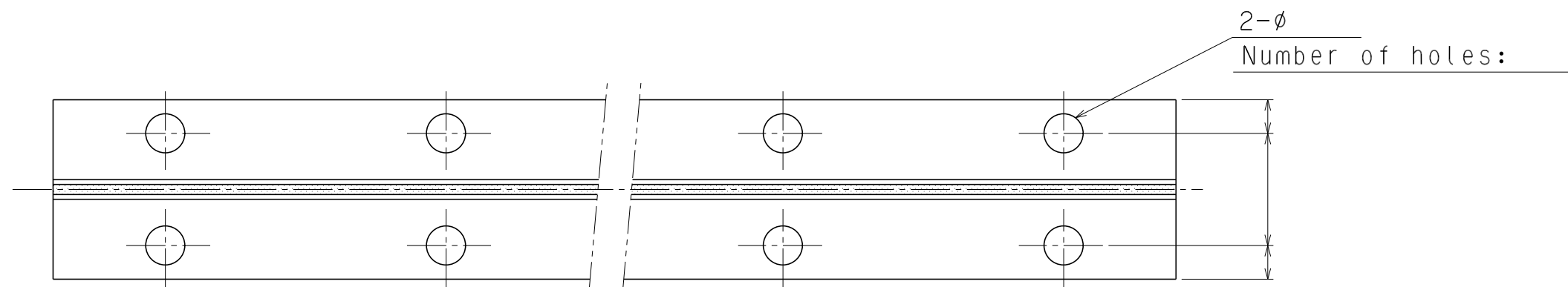

3	BRISTLE	1set			
2	CHANNEL	1set			CH#3
1	PLATE	1			
PARTS No.	PARTS NAME	Q'TY (PER SET)	MATERIAL	WEIGHT (kg)	REMARKS
CUSTOMER;					
APPROVED	TITLE SK Type Strip Brushes(CH#3) (with Plate-T Type)				
CHECKED	SCALE	DRAWING No.			
DRAWN	NTS				
DATE	SHOWA INDUSTRIES CO.,LTD.				

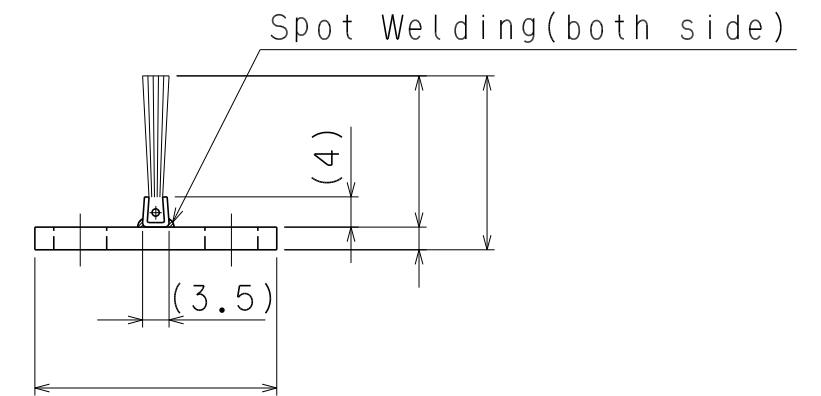
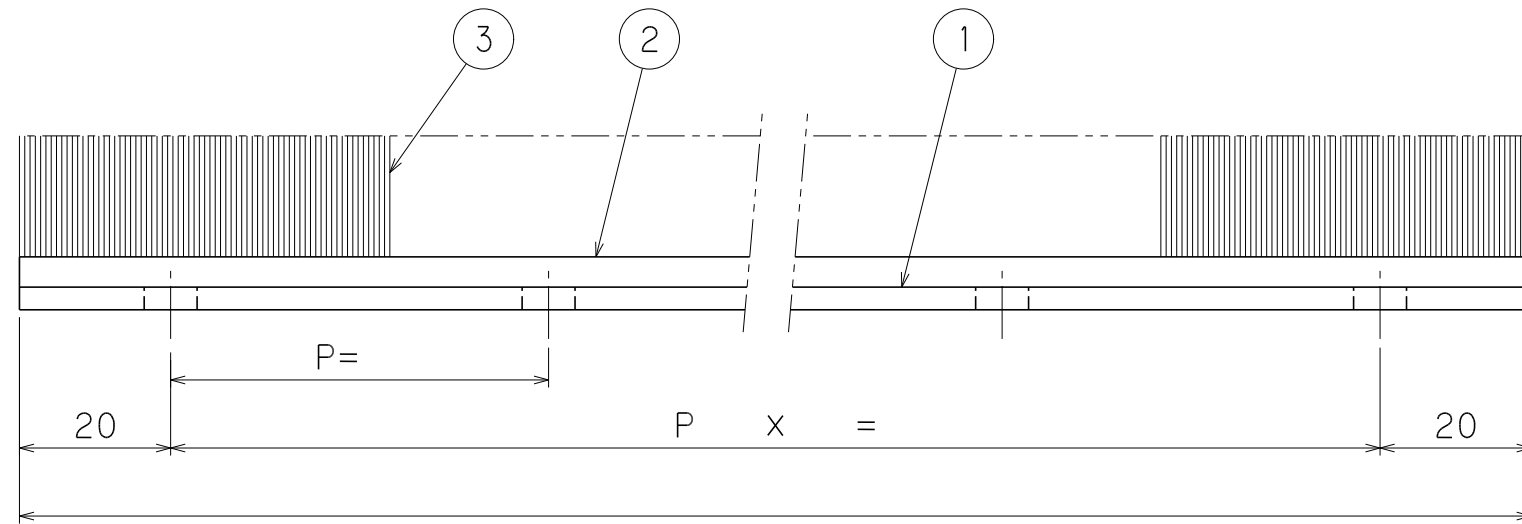