

SURFACE ROUGHNESS						
Ra		25	6.3	3.2	1.6	0.2
Rmax		100S	25S	12.5S	6.3S	0.8S

REV.	DATE	NOTE	DRW.

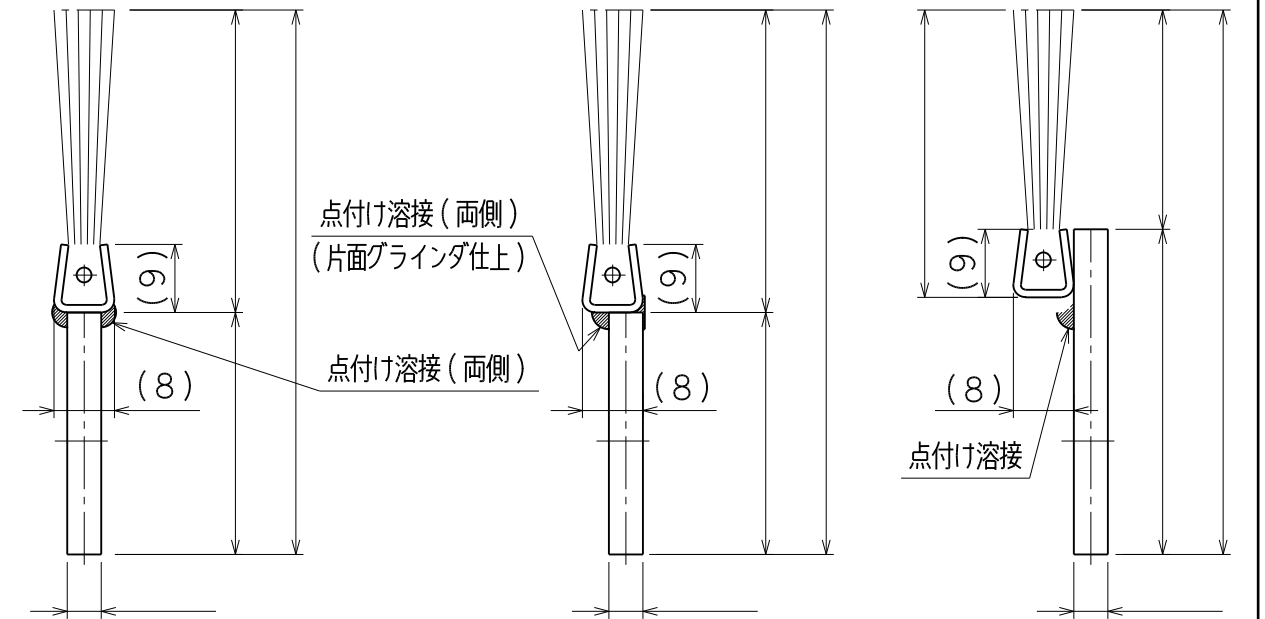
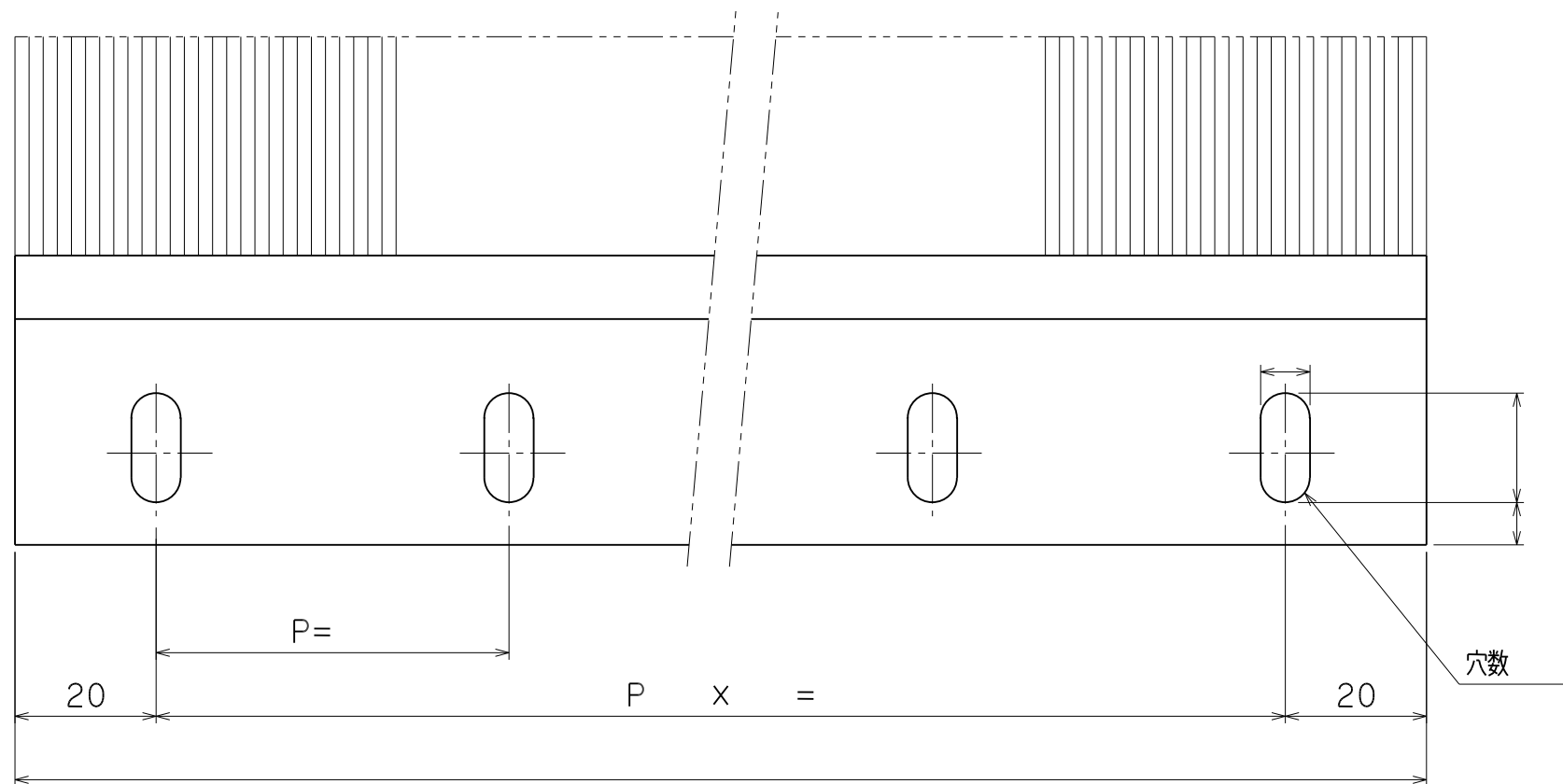
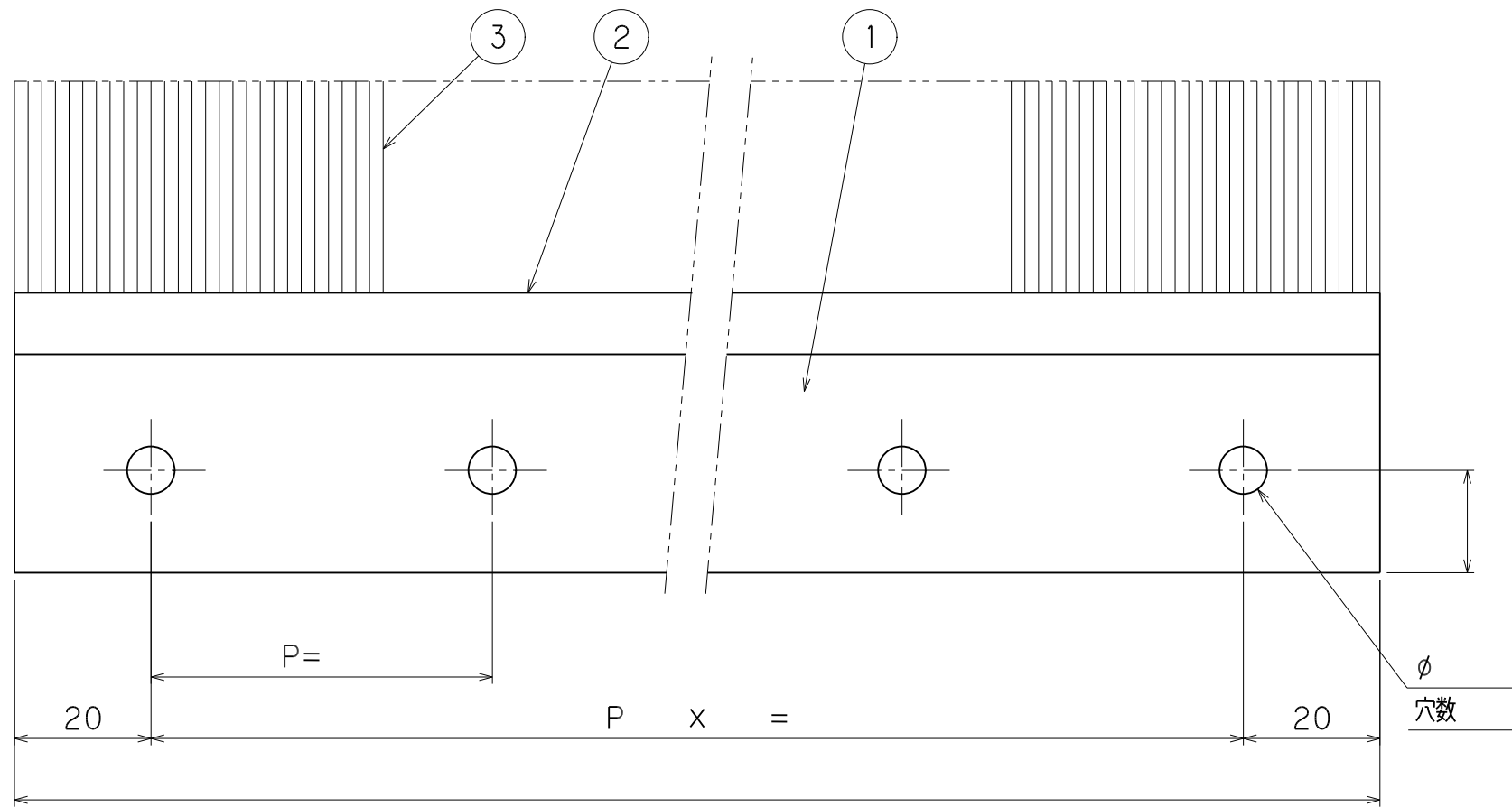

3	ブラシ毛材	1式			
2	チャンネル	1式			CH #8
1	プレート	1			
PARTS No.	PARTS NAME	Q'TY (PER SET)	MATERIAL	WEIGHT (kg)	REMARKS

APPROVED		CUSTOMER;			
CHECKED		TITLE			
DRAWN		SK型直線ブラシ (プレート付-I型) (CH #8)			
DATE		SCALE	DRAWING No.		
		NTS			
SHOWA INDUSTRIES CO.,LTD.					

