

SURFACE ROUGHNESS						
Ra		25	6.3	3.2	1.6	0.2
Rmax		100S	25S	12.5S	6.3S	0.8S

REV.	DATE	NOTE	DRW.

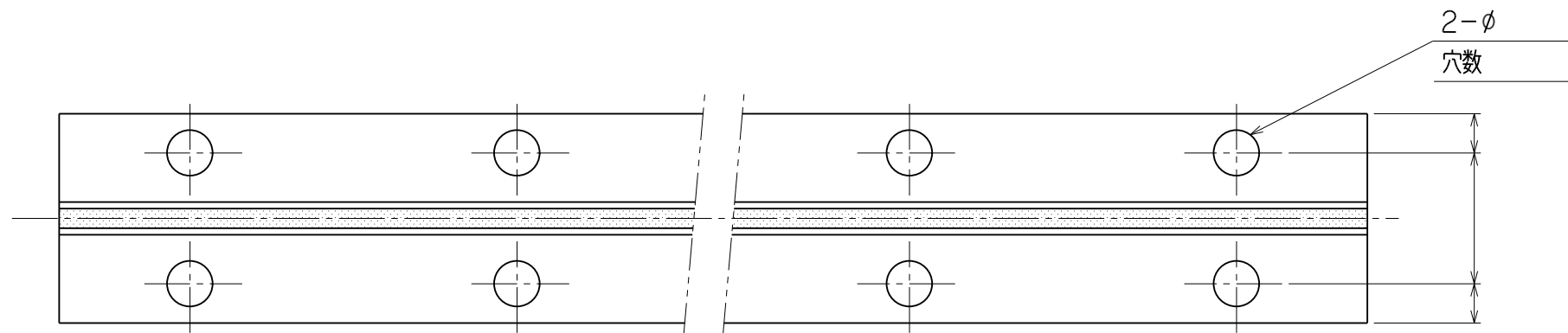
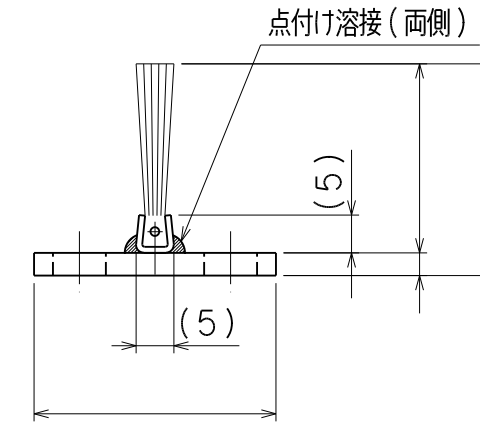
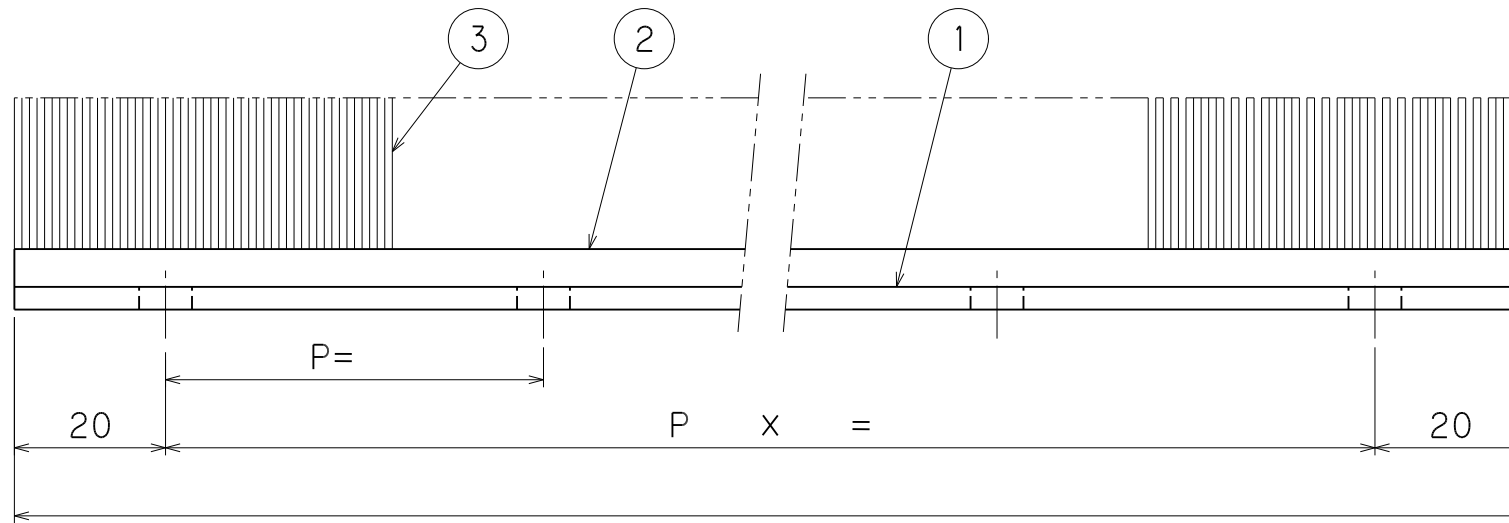

3	ブラシ毛材	1式			
2	チャンネル	1式			CH #5
1	プレート	1			
PARTS No.	PARTS NAME	Q'TY (PER SET)	MATERIAL	WEIGHT (kg)	REMARKS

	CUSTOMER;				
APPROVED	TITLE				
CHECKED	SK型直線ブラシ (プレート付-T型) (CH #5)				
DRAWN	SCALE	DRAWING No.			
DATE	NTS				
SHOWA INDUSTRIES CO.,LTD.					

